

SPECIAL CONDITIONS

Custom Mitred Corners, Finishing

Pittcon offers fabricated intersections made with six inch long legs, twelve inches overall. Longer legs are available as needed for special conditions. Intersections can be supplied in pieces for field assembly, or assembled at the factory. Optional finishes can be factory applied to your extrusions, such as clear or color anodizing, as well as a variety of paint colors. Decorative inserts can be supplied where architectural metal finishes such as polished or brushed chrome or brass are desired. All of these options are detailed below and on the other side of this page. Please contact the factory or your local sales representative for additional information.

Softforms® Drywall Moldings

Condition #18
X-Mitre

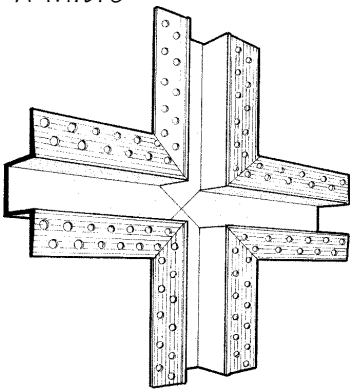

Condition #17
Tee-Mitre

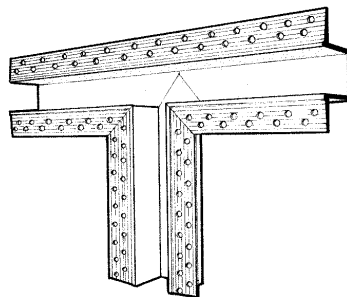

Condition #21 Tee
Mixed-Mitre

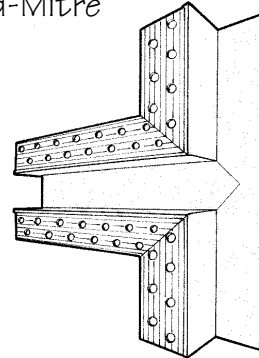

Softforms® Plaster Moldings

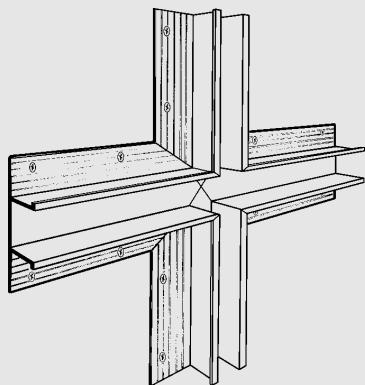

Condition #18
X-Mitre

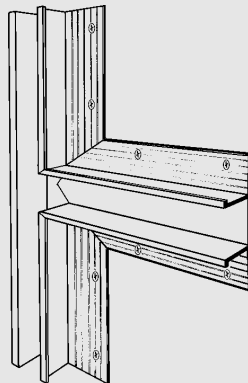

Condition #17
T-Mitre

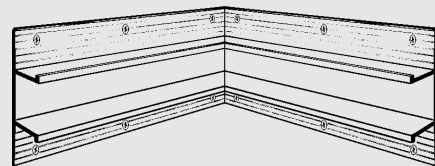

Condition #24
Inside-Mitre

Optional Finishes

The following finishes are available subject to additional charges depending on the quantity ordered, and availability.

- Painted in a high gloss enamel finish in a variety of colors
- Painted in a semi-gloss enamel finish in a variety of colors
- Painted in a Corafon® fluoropolymer finish
- Black anodized finish
- Light, medium, or dark bronze Duranodic finish
- Other color anodized finishes

All paint finishes meet or exceed AAMA standards for scratches or blemishes.

Corafon® is a registered trademark of PPG Industries, Inc.

SPECIAL CONDITIONS

Inside, Outside, Circular/Arched Curving, Bridge & Channel Inserts

Many new construction and renovation projects incorporate radiused wall conditions. To accommodate these conditions Pittcon has perfected the art of extrusion 'radiusing'. We can roll-form most of our wall and trim reveal profiles to match your needs. The four possible radius directions: Inside, Outside, Circular/Arched, are shown below, using an 'SWR' and a "PCS" extrusion for examples. The shapes can be supplied in lengths up to 8'. Not all shapes are equally easy to radius, so please consult the factory for your requirements. Reveal inserts can be supplied in a variety of metals and finishes, including wood. Shown below are the two variations normally supplied. In addition to their decorative value, both methods act equally well as fabric tucks for vinyl wall coverings.

Soffforms® Drywall Moldings

Condition #27
Inside Radius

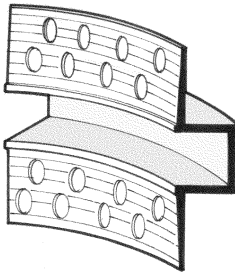

Condition #28
Outside Radius

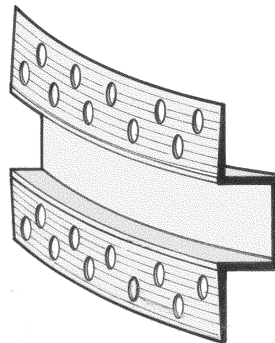

Condition #29
Circular/Arched

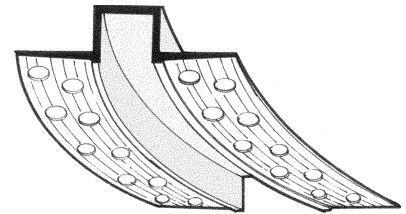

Soffforms® Plaster Moldings

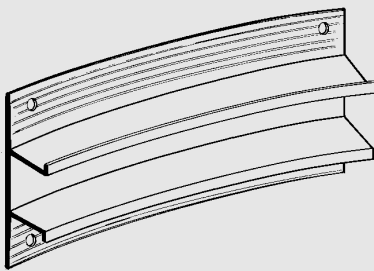

Condition #27
Inside Radius

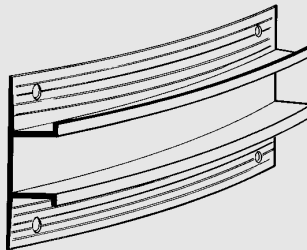

Condition #28
Outside Radius

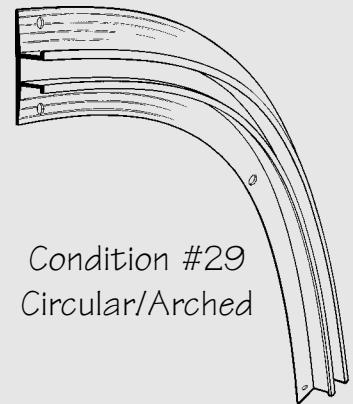

Condition #29
Circular/Arched

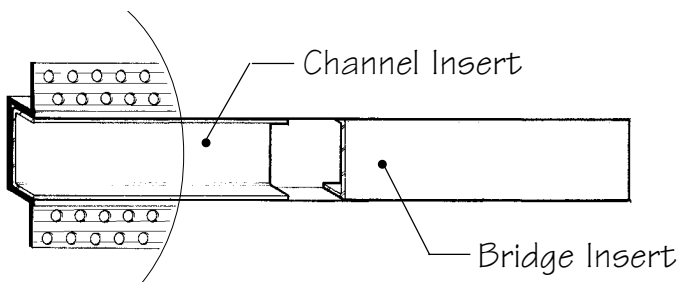

Channel & Bridge Inserts

- In a brushed or polished Nevamar Puremetals® Chrome finish
- In a brushed or polished Nevamar Puremetals® Brass finish
- Painted in a high gloss enamel finish in a variety of colors
- Painted in a semi-gloss enamel finish in a variety of colors
- Painted in a Coraflon® fluoropolymer finish
- Black anodized finish
- Light, medium, or dark bronze Duranodic finish

Nevamar Puremetals® is a registered trademark of Nevamar Corp.



www.dcs-sales.com

8805 Tamiami Trail North, Suite 107
Naples, FL 34108

Florida
Thomas Schreiber
Sales Representative

tom@dcs-sales.com

(407) 648-5348 Phone

(407) 505-4336 Fax

Puerto Rico, US Virgin Islands - Caribbean
Island groups-Lucayan Archipelago
Greater Antilles, Lesser Antilles, Bahamas